

74 Series Datasheet

Modules



XICATO XTM



0 mm

130 mm

Key Features

- ▶ For superior light quality
- ▶ Height under 100 mm using optimised passive thermodynamics
- ▶ Die-cast twist and lock bezel with interchangeable accessories
- ▶ Multi-faceted medium beam reflector with an excellent optical efficiency of 85%
- ▶ IP65 bezel option
- ▶ Various dimming options
- ▶ Emergency conversion options
- ▶ 5 year warranty 50,000 hours
- ▶ Short circuit, overload and temperature protection
- ▶ Comes with 500 mm supply lead

Technical Drawing

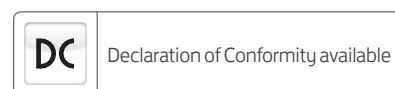
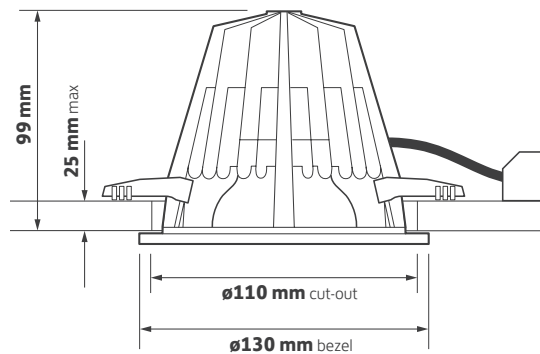

Ordering Information

Output	Power	Colour	Model Ref.
950 lm	9 W	830	74.001
950 lm	9 W	840	74.002
1275 lm	14 W	830	74.003
1275 lm	14 W	840	74.004
1725 lm	19 W	830	74.005
1725 lm	19 W	840	74.006
2550 lm	30 W	830	74.007
2550 lm	30 W	840	74.008

Options

Please select from the options below.

TA200 bezel options	/WH /CH /BA /BL
High colour rendering	R_a >95
SwitchDIM, DALI, DSI	/ECO
EM conversion	/EM
Self-test EM conversion	/EMS
DALI EM conversion	/EMD
Integral indicator for EM conversion	I
Single Point Connection to an ILEM	/SPC
Please see accessories sheet	Accessories

74 Series Datasheet

Options



/NB
Narrow beam reflector



/WB
Wide beam reflector

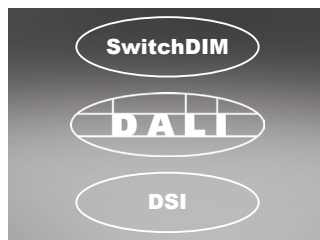

/ECO
SwitchDIM, DALI or DSI



/EM
EM conversion



/EMS
Self-test EM conversion



/EMD
DALI EM conversion



/EMI
Integral indicator for EM conversion



/EMSI
Integral indicator for self-test EM conversion



/EMDI
Integral indicator for DALI EM conversion

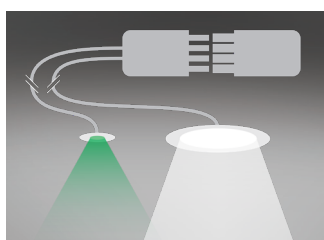

/SPC
Single Point Connection to ILEM product

74 Series Datasheet



Bezel Finish



TA200/WH
White bezel - RAL9010



TA200/CH
Chrome bezel



TA200/BA
Brushed aluminium bezel



TA200/BL
Black bezel - RAL9005

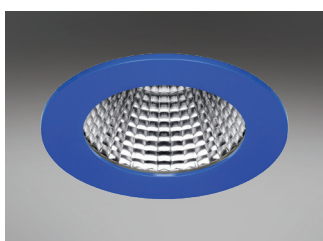

Product variations
Other colours and specifications
available on request



AT200/WH
White anti-tamper bezel



AT200/CH
Chrome anti-tamper bezel



AT200/BA
Brushed aluminium anti-tamper bezel



AT200/BL
Black anti-tamper bezel

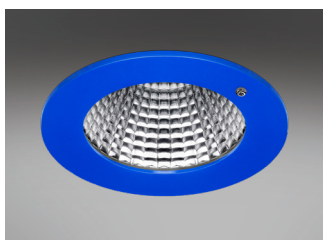

Product variations
Other colours and specifications
available on request

74 Series Datasheet



Fixing Options

Available with selected accessories

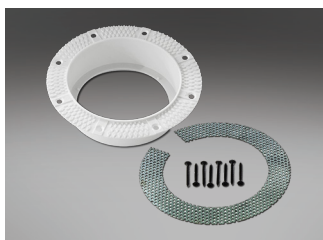

PI200
Plaster-in kit. Please see PI200 datasheet for details.



PI200
Installed kit and fitting. Please see PI200 datasheet for details.



HALOKIT.001
Halo kit - maximum cut-out 150 mm

IP65 Bezel



IP65/001/130
IP65 clear polycarbonate

Decorative Bezel

White /**WH** Chrome /**CH** Brushed Aluminium /**BA** Black /**BL**



TA225/WH
White bezel complete with clear halo



TA226/WH
White bezel complete with opal halo

Accessories



TA220/FROST
Frosted hi-light

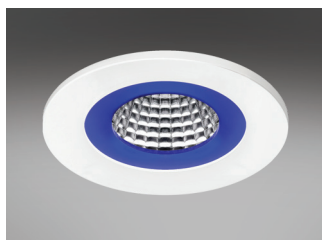

TA220/BLUE
Blue hi-light



TA210/FROST
Frosted vertical halo



TA210/BLUE
Blue vertical halo



TA206
IP54 Glass scatter dome



TA240
IP54 Clear glass



TA241
IP54 Centre etched glass



TA242
IP54 Fully etched glass



TA208
Kick reflector



GF208 / GF218
Anti-tamper driver / Anti-tamper bit