

137 Series Datasheet

Xicato
TECHNOLOGY
INSIDE



Key Features

- ▶ Low glare architectural downlight
- ▶ Discreet minimal bezel, die-cast from pure aluminium
- ▶ Matt black darklight baffle, developed to minimise glare
- ▶ Precision moulded 24° reflector
- ▶ Xicato LED engine and driver system
- ▶ Thermally optimised extruded heatsink
- ▶ Short circuit, overload and temperature protection
- ▶ Life 50,000h L70/B0

Technical Drawing

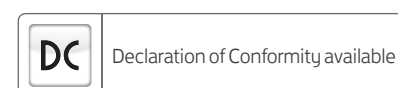
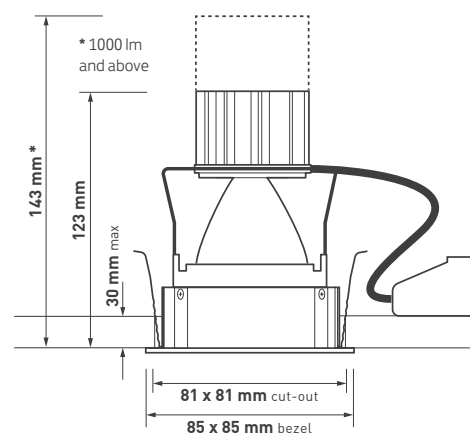

Ordering Information

Engine Output (lm)	Engine Qty	Power (tcW)	Colour	Model Ref.
575	1	10	927	137.001
600	1	10	930	137.002
650	1	10	940	137.003
750	1	14	927	137.004
800	1	14	930	137.005
850	1	14	940	137.006
1000	1	19	927	137.007
1075	1	19	930	137.008
1150	1	19	940	137.009

Also available in 2 (137.2XX) and 3 (137.3XX) engine versions.
For 2 and 3 engine outputs, multiply lIm and tcW by relevant engine quantity.

Options

Please select from the options below.

SwitchDIM, DALI or DSI	/ECO
Narrow beam reflector 16°	/NB
Wide beam reflector 40°	/WB
EM conversion	/EM
DALI and self test EM conversion	/EMD
Plaster-in bezel version	/PI
White softlight baffle	/WSB
Casambi wireless network (inc dim)	/BTC

137 Series Options and Accessories

Options



/NB
16° Narrow beam reflector

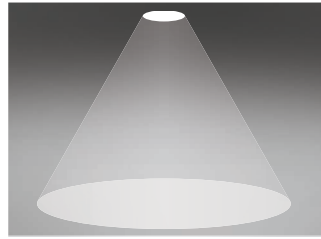

/WB
40° beam reflector

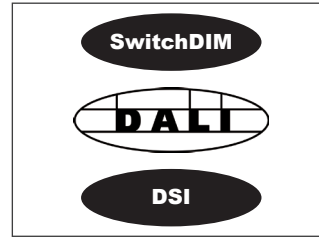

/ECO
SwitchDIM, DALI or DSI

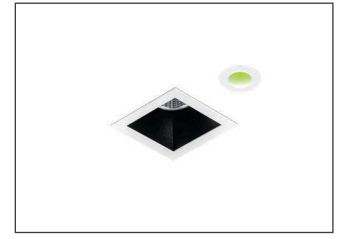

/EM
EM conversion

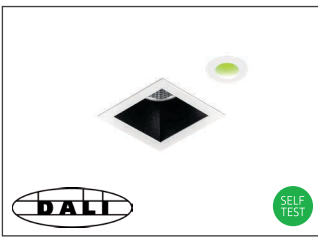

/EMD
Self test and DALI EM conversion



/BTC
Bluetooth / Casambi wireless control (inc dim)

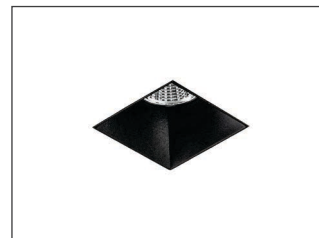

/PI
Plaster-in bezel version (cut-out 81 x 81 mm) single engine only



/WSB
White softlight baffle

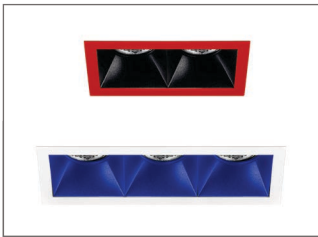

Product variations
Other colours and specifications available on request

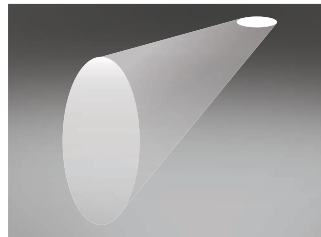

Wall wash available
Please see 138 Series datasheet



Round available
Please see 135 Series and 136 Series datasheets

Also Available

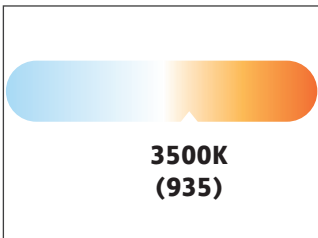

3500K
PV Option



XICATO XIM GalaXi
PV Option



XICATO VIBRANT Ra80
PV Option



XICATO ARTIST Ra95
PV Option